



VIGOR PRECISION LTD 力嘉精密有限公司

Flat A1, A4-A8, 8/F, Block A, Texaco Road Industrial Centre, 256-264 Texaco Road, Tsuen Wan Hong Kong
 香港荃灣德士古道256-264號德士古道工業中心A坐8字樓A1, A4-A8 室

Tel電話: (852)2407 5498(8 lines) Fax傳真: (852) 2407 3148

E-mail電子郵件: enquiry@vigorprecision.com.hk

Web Site網址: http://www.vigorprecision.com.hk

BO-P5 RATIO 1:70 WITH R260 MOTOR (planetary gearbox)

OUTPUT : 0.3W~24 W (APPROX)

WEIGHT : 48g

Typical applications : Consumer Electronic Products
 Personal Care Product
 Office Automation Equipments
 Toys and Models

Household Appliances
 Massager / Vibrator
 Power Tools



Model	Gear ratio	Voltage (V)	No Load		Max Efficiency (%)			Max Output (W)			Stall	
			Speed (rpm)	Current (A)	Speed (rpm)	Current (A)	Torque (kgf.cm)	Speed (rpm)	Current (A)	Torque (kgf.cm)	Torque (kgf.cm)	Current (A)
BP5-N70R260-18130D	70	4.5	136	0.25	108	0.60	0.63	68	1.10	1.51	3.02	2.00
BP5-N70R260-2670D	70	3.0	172	0.35	142	1.05	0.63	86	2.40	1.89	3.78	4.71

For Reference Only

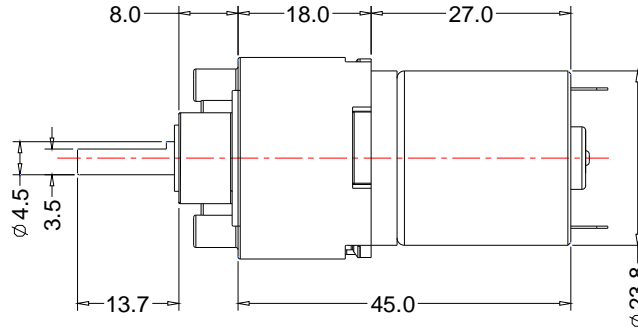
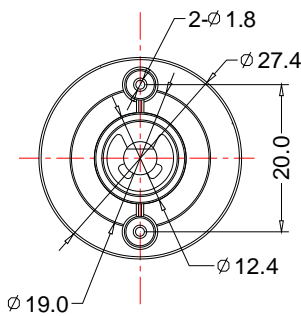

Unit:mm

BP5-N70R280-18130D 4.5V

BP5-N70R280-2670D 3.0V

